

# SA226/1 Single Fan Oven

## Manual for Installation, Use and Maintenance

# CDA



## Important

This appliance must only be used for the purpose for which it is intended, i.e. domestic cooking. Any other use could be dangerous and may lead to premature failure of the appliance.

The CDA Group Ltd cannot be held responsible for injuries or losses caused by incorrect use or installation of this product. Please note that CDA reserve the right to invalidate the guarantee supplied with this product following incorrect installation or misuse of the appliance.

Under no circumstances should any external covers be removed for servicing or maintenance except by suitably qualified personnel.

### User information:

- Ovens become hot during and immediately after use.
- The oven door can become very hot during operation.
- After use, please ensure that the oven switches are in the 'Off' position.
- Keep children away from the appliance when in use, and immediately after use.
- Keep the oven door closed whilst grilling.

### Appliance information:

Please enter the details on the appliance rating plate below for reference, to assist CDA Customer Care in the event of a fault with your appliance and to register your appliance for guarantee purposes.

Appliance Model

Serial Number

### CE Declarations of Conformity:

This oven has been designed, constructed and marketed in compliance with safety requirements of EEC Directive 2006/95/EEC (Low voltage) and requirements of EMC Directive 2004/108/EEC.

This appliance has been manufactured to the strictest standards and complies with all applicable legislation, including Electrical safety (LVD) and Electromagnetic interference compatibility (EMC). Parts intended to come into contact with food conform to EEC/89/109.4

### IMPORTANT INFORMATION FOR CORRECT DISPOSAL OF THE PRODUCT IN ACCORDANCE WITH EC DIRECTIVE 2002/96/EC.

At the end of its working life, the product must not be disposed of as urban waste. It must be taken to a special local authority differentiated waste collection centre or to a dealer providing this service.

Disposing of a household appliance separately avoids possible negative consequences for the environment and health deriving from inappropriate disposal and enables the constituent materials to be recovered to obtain significant savings in energy and resources. As a reminder of the need to dispose of household appliances separately, the product is marked with a crossed-out wheeled dustbin. 

## Important

- Read the user instructions carefully before using the oven for the first time.
- Follow the instructions for first use of the oven.
- Clean the oven regularly.
- Remove spills as soon as they occur.
- Always use oven gloves when removing shelves and trays from the ovens.
- Do not allow children near the oven when in use.
- Do not allow fat or oils to build up on the oven shelves, grill pan or oven base.
- Do not place any cooking utensils or plates directly on the oven base.
- Always grill with the oven door closed.
- Do not grill food containing fat without using the grill pan grid.
- Do not cover the grill pan grid or the oven walls with aluminium foil.
- Do not use the oven tray for roasting.
- Do not perform maintenance or cleaning of the oven without first switching off the electricity supply. If the oven has recently been used, allow to cool.
- Do not place hot enamel parts in water. Leave them to cool first.
- Do not allow vinegar, coffee, milk, saltwater, lemon or tomato juice to remain in contact with enamel parts.
- Do not use abrasive cleaners or powders that will scratch the surface of the enamel.
- Do not attempt to repair the internal workings of your oven.

## First use of the oven

### First use

- Before using the oven for the first time we recommend that you clean the oven with soapy water, rinse carefully and then heat on each of the below programmes at maximum temperature for the specified time. A slightly unpleasant smell may be produced, caused by grease remaining on the oven elements from the production process.

 15 minutes grill.

 60 minutes fan oven.

### Please note:

- This oven has been fitted with a cooling fan to achieve maximum efficiency and to maintain low surface temperatures. The cooling fan will switch on automatically when the oven is switched on and switch off automatically when the oven is switched off.
- The oven light remains on for every cooking function.

## Oven controls and use

### Cooking function knob

To set the function, turn the cooking function knob clockwise to the required function.

Each of the oven functions uses different elements within the oven to offer you the best choice of cooking every time. These are explained below:



#### Fanned Grill

This function uses the fan to circulate the heat from the grill element around the food. The temperature must be set at 200°C



#### Grill

This function radiates the heat from the grill element. The temperature must be set at 200°C

For each grill function please note:

- Always grill with the oven door closed.
- Put the grill pan as close to the grill as possible.
- Do not grill for more than 30 minutes at a time.
- Preheat the grill for approximately five minutes with the oven door closed.



#### Defrost

Using the fan only this oven function circulates the air around the oven cavity, speeding up the natural defrost process (1kg takes approximately one hour, depending on the type of food).



#### Fan Oven

Using the circular element and the fan with a temperature between 50°C and Max, this cooking function blows the air into and around the oven cavity. Temperatures are achieved quicker, reducing or even removing the need for preheating. Both cooking temperatures and cooking times can be reduced for a more energy efficient cooking programme.

Perfect for cooking various food types simultaneously as foods are sealed quickly to prevent flavour transfer.

### Temperature knob

- To set the temperature, turn the temperature knob clockwise to the required temperature.
- Once the oven has reached the required temperature, the temperature indicator lamp on the control panel will switch off.
- The temperature indicator lamp will light up when the oven elements are working.

## Programming the oven

**PLEASE NOTE: The display brightness automatically reduces between the hours of 22.00 and 06.00.**

The alert beep will cut off after two minutes if it is not switched off manually.

### Setting the clock

The clock is preset to 00:00, and will revert to this after a power failure.

- With the oven switched off, press buttons 1 and 2 at the same time.
- Select the correct time by pressing the increase and decrease buttons within four seconds. When the correct time is shown on the display, the clock will set after approximately four seconds' delay.

### The minute minder

The minute minder can be used when the oven is switched on or off. It can be set for up to 23 hours and 59 minutes.

#### To set the minute minder:

- Press button 1.
- Then press the increase and decrease buttons to select the required duration for the minute minder. When the correct duration shows on the display, the minute minder will set after approximately four seconds' delay.
- A bell symbol will show in the clock display to indicate the minute minder is on.
- When the countdown is complete, there will be a beep which will continue for two minutes. To switch off the beep, press one of buttons 1 - 4.

#### Please note :

At the end of the countdown, the minute minder will not switch off the oven. Remember to turn off the oven manually.

#### To set a semi-automatic programme

1. Select the required function and temperature (the oven will switch on).
2. Press button 2 and then press the increase and decrease buttons to select the required duration of cooking. auto will show on the clock display.

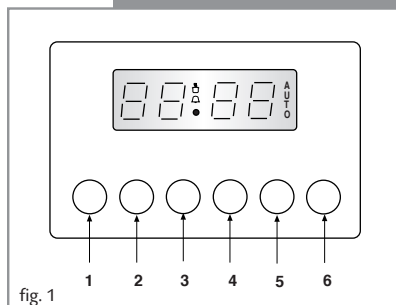

### **To set a fully automatic cooking programme, follow step 1 and 2 above, and then:**

3. Press button 3 and then press the increase and decrease buttons to select the required end time for cooking. AUTO will show on the clock display.

To check on the time remaining on the programme, press button 2.

When the cooking time is completed, the timer will beep. To switch off the beep, press any one of buttons 1 - 4. Then switch off the oven by turning the control knobs to the off position and pressing button 4 to set the programmer to manual.

### **To cancel a programme**

Press button 2 and then press the increase or decrease buttons to set the required cooking time to 00.00. When the actual time is shown on the clock display, then press button 4. This will only cancel the programme, not switch off the oven.

The programme will be cancelled after a power failure.

Once a programme is set, the cooking function and temperature can be changed at any time without affecting the set programme.

### **Please note :**

At the end of a programme, the timer will not switch off the oven. Remember to turn off the oven manually.

## **Childlock**

The oven is equipped with a childlock to lock the controls and so to prevent the oven being used.

### **To switch on the childlock:**

- Press and hold buttons 1 and 2 simultaneously for approximately eight seconds, until the display shows ON.
- Press button 6 so the display shows OF and the key symbol. The childlock is switched on and the display will show the current time and key symbol.

### **To switch off the childlock:**

- Press and hold buttons 1 and 2 simultaneously for approximately eight seconds, until the display shows OF.
- Press button 6 so the display shows ON. The childlock is switched off and the display will show the current time only.

## Changing the Oven Lamp

**Before any maintenance is started involving electrical parts, the appliance must be disconnected from the power supply.**

**If the oven has been in use, let the oven cavity and the heating elements cool down before attempting any maintenance.**

### Changing the bulb (fig. 2)

- Unscrew the protective cover.
- Unscrew and replace the bulb with the new one suitable for high temperatures (300°C) having the following specifications: 230-240V 50Hz, 15W, E14.
- Refit the protective cover.

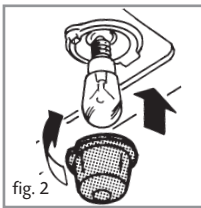

**IMPORTANT: Never use screwdrivers or other utensils to remove the light cover. This could damage the enamel of the oven or the lamp holder. Remove only by hand.**

### Please note:

The bulb replacement is not covered by your guarantee.

## Cleaning and Maintenance - Removing the Oven Door

**The oven doors can easily be removed as follows:**

- Open the door fully.
- Open the lever on the left and right hinges (as show in figure 2).
- Gently close the door until left and right hinge levers are hooked to the door.
- Lift the door by removing the hinge hooks from their location in the direction indicated.
- Rest the door on a soft surface.
- To replace the door, repeat the above steps in reverse order.

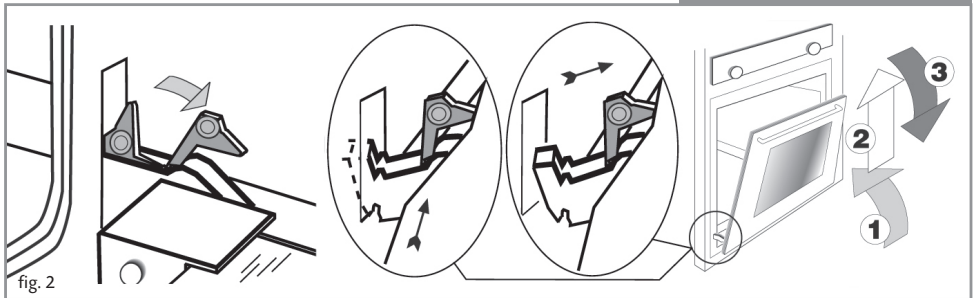



## Cleaning and Maintenance - Removing the Oven Door Inner Glass

### To remove the inner pane of the top oven door on both sides

1. Remove the oven door as shown above.
2. Release the two upper blocks by pressing down as shown in fig. 4.
3. Slide the door glass out in the direction shown in fig. 4.1.
4. Clean the glass with an appropriate cleaner, dry thoroughly and place on a soft surface.
5. Now you can also clean the inside of the outer glass.

### To replace the inner glass

1. Ensuring the OK symbol on the glass is facing you, slide the glass back into the frame.
2. Replace the upper blocks, ensuring they lock back into place.
3. Replace the oven door.

**IMPORTANT: Do not clean the glass whilst it is still hot.**

**Please keep the ok symbol to the bottom right of the oven door (fig. 4.1).**

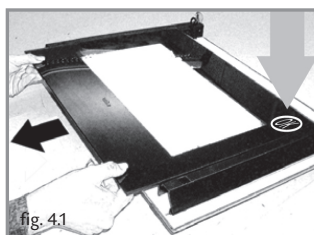
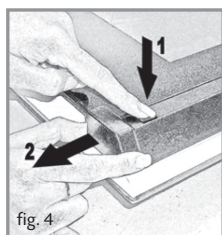

## Installation

### Important

If the oven is being installed into a built under oven housing unit ensure that the front rail at the top of the unit is not installed as it could restrict ventilation.

Ensure that air can flow freely around the housing area. If the oven is being installed into a fully enclosed built-under oven housing unit it may be necessary to cut a small slot in the top of the plinth fitted under the unit. Cut a section 400mm wide and a minimum of 15mm high to allow air to pass under the unit. Alternatively cut a section 400 x450mm in the base of the carcass as indicated.

Failure to allow adequate ventilation to the appliance may result in overheating or damage to adjacent units and could invalidate the warranty.

This appliance is type X installation.

The walls of the kitchen units must be able to withstand temperatures of 75°C above ambient (typically this is between 90°C and 100°C).

When correctly installed ensure that there is a gap of 4mm minimum between the sides of the oven and adjacent furniture doors.

Lift the oven carefully into position on the shelf, taking care NOT to lift it by the door handle. If you lower the oven door, you will see 4 screw holes, 2 on each side of the oven. The oven should then be secured to the housing by fitting screws into these holes. Remember the housing should not be free standing but be secured to the wall and/or adjacent fittings.

### How to install your oven

You will need the following housing area fit your oven correctly.

Dimensions	Oven	Housing
Height (mm)	598	575
Width (mm)	598	560
Depth (mm)	515	560 (min)

The oven is designed to fit into a cabinet of 600mm width. The oven can be built in or built under the kitchen units, but you must ensure that it is properly ventilated. In the diagram the built-in oven is ventilated by means of a space at the top of the kitchen cabinet. There are many other methods of ventilating your oven - Consult a qualified engineer for advice.

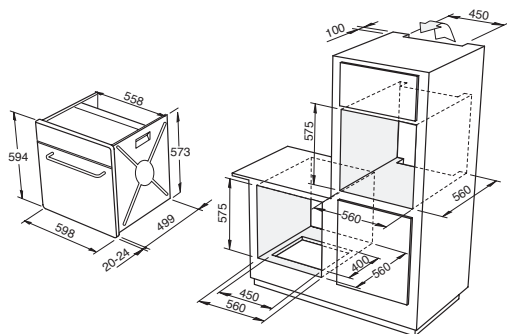

fig. 4

## Electricity supply to your oven

**Warning! this appliance must be earthed.**

This appliance must be connected by a competent person, using fixed wiring via a double pole switched fused spur outlet.

We recommend that the appliance is connected by a qualified electrician, who is a member of the N.I.C.E.I.C. and who will comply with the I.E.E and local regulations. The wires in the mains lead are coloured in accordance with the following code:

**GREEN AND YELLOW = EARTH BLUE = NEUTRAL BROWN = LIVE.**

As the colours of the wires in the mains lead for the appliance, may not correspond with the coloured markings identifying the terminals in your spur box, proceed as follows:

1. The wire which is coloured green and yellow must be connected to the terminal marked E (Earth) or coloured Green.
2. The wire which is coloured blue must be connected to the terminal marked N (Neutral), or coloured Black.
3. The wire which is coloured brown must be connected to the terminal marked L (Live), or coloured Red.

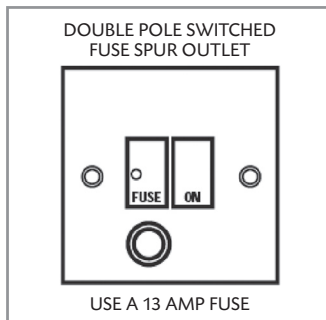



# |C|D|A|

To contact our Customer Care Department, or for Service,  
please contact us on the details below.